

60" CLASS (59.5" DIAGONAL)

60PG30FC

PLASMA TV

Plasma Widescreen Commercial HDTV with Full HD Resolution



FULL HD 1080p RESOLUTION
1920 x 1080 Native Resolution

NEW! 4 POWER SAVING LEVELS

IMPROVED! LIFE SPAN (typical)
100,000 hours to half brightness (approx.)

NEW! INVISIBLE SPEAKER SYSTEM
No visible speaker grilles

BUILT-IN TUNERS
ATSC/NTSC/Clear QAM

PUBLIC DISPLAY SETTINGS
Cloning capable with
optional TVLink-Loader, TLL-1100A

IMPROVED! DYNAMIC CONTRAST RATIO
30,000:1

HIGH BRIGHTNESS
1000 cd/m²

NEW! LG'S EXCLUSIVE DUAL XD ENGINE®

NEW! ISFccc CALIBRATION READY

NEW! FLUID MOTION
180Hz Effect

PRO:IDIOM® CAPABLE
using optional HCS5610 pay-per-view box

IMPROVED! 3 HDMI™ INPUTS
V.1.3 with deep color

PC INPUT

RoHS AND ENERGY STAR® COMPLIANT

HIGH-GLOSS BLACK CABINET
Slim Depth (3.5")

2-YEAR LIMITED WARRANTY
(parts/labor)

www.LGcommercial.com



DUAL X^D ENGINE

Combines two of LG's exclusive XD Engines to help maximize picture quality for any kind of video content. By combining XD Engine processors, panel performance is optimized ensuring higher-quality, more realistic images.

INTELLIGENT CONTRAST IMPROVES LOW RESOLUTION LEVELS, BLACK AND WHITE SATURATION AND COLOR COMPENSATION RELATED TO DYNAMIC CONTRAST USING A HISTOGRAM DEVELOPED FOR LOW PEAK LEVELS.



Dramatization

FRESH COLOR SKIN, GRASS AND SKY COLORS ARE OPTIMIZED TO THE NEAREST TRUE COLOR.



Dramatization

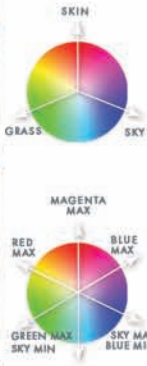

SPECIAL FEATURES

CLEAR VOICE

BALANCED SOUND TO EMPHASIZE DIALOGUE

Designed to automatically enhance and amplify the sounds of the human voice frequency range, Clear Voice Technology helps keep dialogue audible when background noises swell.



invisible SPEAKER

SOUND IS HEARD, NOT SEEN

Breaking through the fixed idea that speaker grills must be exposed, the Invisible Speaker design provides a "full sweet spot" and more realistic sound. Personally tuned by Mr. Mark Levinson, world-renowned audio authority, this unique design has rich and lively sound that can be enjoyed from any angle.



Fluid Motion With 180Hz effect Response Time 0.001ms

CLEARER HIGH SPEED IMAGES

Fluid motion has an astonishing response speed of 0.001ms making fast moving images appear sharper and more natural.



Dramatization

Dramatization



CALIBRATION READY

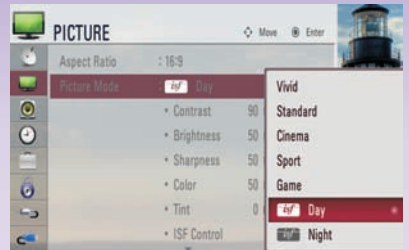

PUBLIC DISPLAY SETTINGS

CLONING CAPABLE with optional TVLink-Loader, TLL-1100A

When used in public areas, these HDTVs can be easily programmed by the installer to have the TV turn on at a specified channel/volume level, set the minimum/maximum volume, lock out the control panel/remote, set the aspect ratio, and return to a factory reset. By using Power Management, these displays can be programmed to turn off if there has been no activity (remote or control panel buttons) for a preset time (1-7) hours.

Public Display Settings

| | |
|---------------------|-----|
| Public Display Mode | Yes |
| Start Channel | Yes |
| Ch. Type | TV |
| Major | 2 |
| Minor | 0 |
| Minimum Volume | 0 |
| Maximum Volume | 100 |
| Start Volume | Yes |
| Level | 20 |
| Power Management | Yes |
| Setting | 1 |
| Key Management | 0 |
| Factory Reset | 0 |
| Aspect Ratio | 0 |

EDGE DETECTION TECHNOLOGY TO HELP PREVENT DISTORTION.

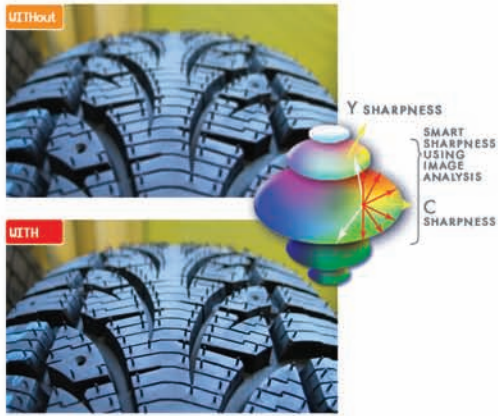

Dramatization

DYNAMIC BLACK STRETCH THE MINIMUM BLACK LEVEL OF AN IMAGE IS AUTOMATICALLY DETECTED AND ADJUSTED ACCORDING TO BRIGHTNESS.

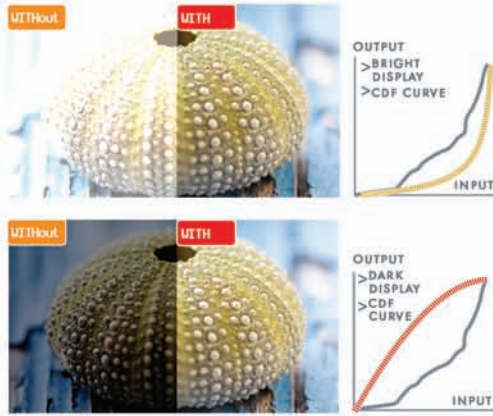

Dramatization

CLEAR SCREEN USING THE NOISE FILTER INSIDE THE XD ENGINE CHIP, THE IMAGE IS ANALYZED FOR TEMPORAL AND SPATIAL INFORMATION TO REDUCE MPEG NOISE.

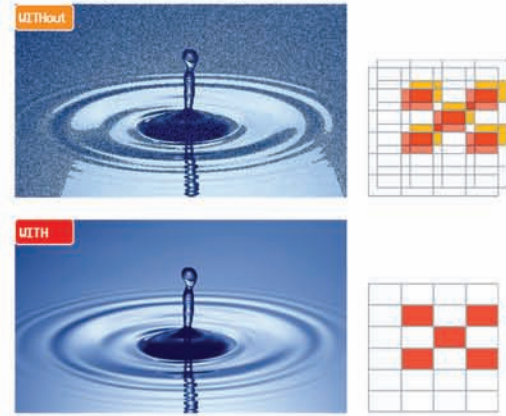

Dramatization

4 POWER SAVING LEVELS

By selecting 1 of 4 levels of brightness, a reduction in power consumption is achieved resulting in energy savings and lower costs.

60PG30FC in Vivid Mode

| | BRIGHTNESS (cd/m ²) | *POWER CONSUMPTION (Watts) |
|---------|---------------------------------|----------------------------|
| Level 0 | 181 | 499W |
| Level 1 | 98% of Level 0 | 95% of Level 0 |
| Level 2 | 73% of Level 0 | 79% of Level 0 |
| Level 3 | 60% of Level 0 | 68% of Level 0 |
| Level 4 | 45% of Level 0 | 56% of Level 0 |

*Power consumption was measured using IEC62087 dynamic broadcast - content video signal
Note: This model has a ± 5% deviation from unit to unit

MENU SELECTABLE

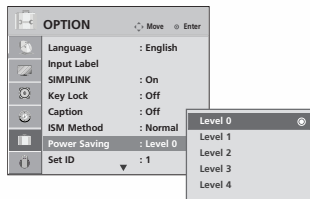

REMOTE CONTROL



DIMENSIONS

60PG30FC

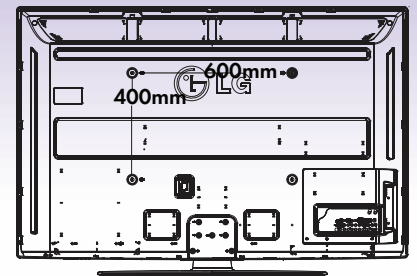
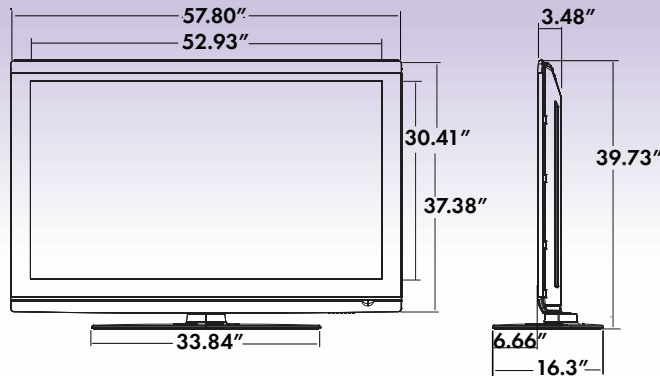

REAR JACK PANEL

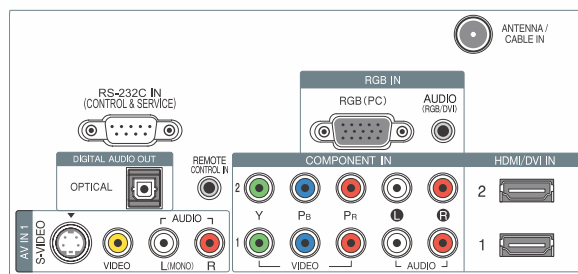

SIDE JACK PANEL

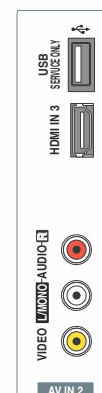

60PG30FC

60" CLASS (59.5" DIAGONAL)

SPECIFICATIONS

PLASMA MODULE

| | |
|---------------------------------------|--------------------------------|
| Panel type | 60" |
| Display Area | 59.5" diagonal |
| Native Display Resolution | 1920 x 1080 |
| Viewing Angle | 178°/178° |
| Brightness (cd/m ²) | 1,000 |
| Dynamic Contrast Ratio | 30,000:1 |
| Non-Reflective Black Matrix Structure | Yes |
| Fluid Motion (180Hz Effect) | Yes (smoother, clearer motion) |
| Pure Black Level | Yes |
| Life Span (approx.) | 100,000 hours (typ.) |

VIDEO

| | |
|---|---|
| Analog | Yes |
| ATSC/NTSC/Clear QAM | Yes |
| Dual XD Engine | Yes |
| Aspect Ratio | 16:9 |
| Aspect Ratio Correction | 6 Modes (16:9, Just Scan, 4:3, Set by Program, Zoom 1, Zoom 2) |
| Just Scan (1:1 Pixel Matching) | HDMI 1080p/1080i/720p |
| 0% OverScan | Component 1080p/1080i/720p RF 1080i/720p |
| Enhanced Line Doubler | Yes |
| Enhanced Noise Reduction | Yes (3D & MPEG) Video Noise Filter |
| ISM (Image Sticking Minimization) | 3 Modes (White Wash/Orbiter/Inversion) |
| Digital Comb Filter | 3D |
| DLTI (Digital Luminance Transient Improver) | Yes |
| DCTI (Digital Color Transient Improver) | Yes |
| Color Temperature Control | 3 Modes (Cool, Medium, Warm) |
| Black Stretcher (Black Level Enhancer) | Yes |
| 24p Cinema (Film Mode) | Yes (2:2, 3:2 pulldown) |
| 3:2 Pulldown | Yes |
| Picture Reset | Yes |
| AV Mode (Picture & Sound) | 3 Modes (Cinema /Sport/Game) |
| ISFccc Calibration Ready | Yes |
| Picture Selection Mode | 7 Modes (Vivid, Standard, Cinema, Game, Sports, Expert1, Expert2) |

| | |
|-------------------------------------|--------|
| DTV Signal Strength (Digital) | Yes |
| Color Reproduction (Chassis Output) | 10 Bit |

AUDIO

| | |
|--------------------------------------|--|
| Mono/Stereo/Dual (MTS/SAP) | Yes |
| Audio Output Power (Watts - THD 10%) | 10W + 10W |
| Speaker System Details | 2 Way 4 Speakers |
| Invisible Speaker System | Yes (no visible speaker grilles) |
| Dolby® Digital Decoder | Yes |
| Surround System Type | SRS TruSurround XT™ |
| Bass/Treble/Balance Controls | Yes |
| Auto Volume Leveler | Yes |
| Sound Mode | 5 Modes (Standard, Music, Cinema, Sport, Game) |
| Mute | Yes |

POWER

| | |
|-----------------------|--|
| 4 Power Saving Levels | Yes |
| Voltage Hz | 100-240V, 50/60 Hz |
| Consumption (typical) | 690W (measured with static image pattern) 499Wh (measured with video signal - IEC62087 dynamic broadcast) |
| Stand-by Consumption | Under 1W |

SPECIAL FEATURES

| | |
|-------------------------|--|
| Public Display Settings | Yes |
| Program Guide Type | Brief Info |
| 1080p Source Input | HDMI 60p/30p/24p Component 60p/30p/24p RGB 60p |

| | |
|---------------------------------------|--|
| A/V Input Navigation | Yes |
| Input Labeling | VCR, DVD, Blu-ray, HD DVD, Set-Top Box, Satellite, Cable Box, Game, PC |
| Quick View (Previous Channel) | Yes |
| Clear Voice (On/Off) | Yes |
| Quick Setup Guide | Yes |
| Parental Control w/V-Chip | Yes |
| Key Lock | Yes |
| Closed Caption | Yes |
| LG Simplink™ (HDMI CEC) | Yes |
| Trilingual Menus | English/French/Spanish |
| EZ Menus (High Performance Interface) | Yes |
| Channel Add/Delete | Yes |
| Favorite Channel | Yes |
| Auto Clock | Yes |
| Manual Clock | Yes |
| On/Off Timer | Yes |
| Sleep Timer | Yes |
| Auto Off (When no video is present) | Yes |

COMPATIBILITIES

| | |
|--------------------------------|--------------------------------------|
| Pro:Idiom | Yes (using HCS5610 pay-per-view box) |
| Optional Auto-Sensing Jackpack | Yes (using HCS5610 pay-per-view box) |

SIDE INPUTS

| | |
|--------------------------------|---------------------------|
| Composite Video In + L/R Audio | 1 |
| HDMI/HDCP Input | 1 (V.1.3 with Deep Color) |
| USB 2.0 | 1 (Service Only) |

REAR INPUTS

| | |
|------------------------------------|---------------------------|
| RF In (Antenna/Cable) | 1 |
| Composite Video In + L/R Audio | 1 |
| S-Video In | 1 |
| Component In (Y,Pb,Pr) + L/R Audio | 2 |
| HDMI/HDCP Input (DVI w/adapter) | 2 (V.1.3 with Deep Color) |
| RGB In (D-Sub 15pin) - PC | 1 |
| PC Audio Input | 1 |
| RS-232C In (9pin male D-sub) | 1 (Control/Service) |
| Remote Control In (IR) | 1 |

REAR OUTPUTS

| | |
|-----------------------------|---|
| Digital Audio Out (Optical) | 1 |
|-----------------------------|---|

OPERATING ENVIRONMENTS

| | |
|---------------------------|---------------------------------|
| Storage Temperature Range | -4° F to 140° (-20°C to 60° C) |
| Storage Humidity Range | under 85% |
| Altitude | up to 9,514 ft. (2,900m) |
| Operating Temperature | 32° F to 104° F (0° C to 40° C) |
| Operating Humidity Range | under 80% |

REQUIRED LISTINGS UL, C-UL, FCC

| | |
|-----------------------|-----|
| RoHS Compliant | Yes |
| ENERGY STAR Compliant | Yes |

SUPPLIED ACCESSORIES

| | |
|---|-----|
| Owner's Manual & CD | Yes |
| Power Cord (6 ft.) | Yes |
| LG Universal Remote Control & Batteries | Yes |
| Cable Management Clip | Yes |

COMPATIBLE FORMATS

| | |
|--|-------------|
| HDTV, NTSC, ATSC, VGA, SVGA, XGA, WXGA | Yes |
| Maximum Computer Resolution (RGB) | 1920 x 1080 |

CABINET SPECIFICATIONS

| | |
|------------------------------------|-------------------------|
| Cabinet Style | Table Top |
| Cabinet Color | Glossy Piano-black |
| Stand Swivel (degrees) | 20° / 20° |
| VESA® Mounting Compatible (W x H) | 600mm x 400mm, M8 screw |
| Dimensions w/o stand (WxHxD) | 57.8" x 37.3" x 3.5" |
| Weight w/out stand | 116.0 lbs |
| Dimensions w/stand (W x H x D) | 57.8" x 39.7" x 16.3" |
| Weight w/stand | 133.6 lbs |
| Dimensions w/packaging (W x H x D) | 63.6" x 44.9" x 20.3" |
| Weight in package | 150.8 lbs |
| UPC | 7 19192 17430 6 |

LIMITED WARRANTY

| |
|------------------------|
| 2 Year (Parts & Labor) |
|------------------------|

www.LGcommercial.com

LG Electronics U.S.A., Inc.
Commercial Products Division
2000 Millbrook Drive
Lincolnshire, IL 60069

Customer Service: 888.865.3026

Contact Your LG Regional Sales Representative:
Enterprise: 800.897.8788
Hospitality: 800.228.1236
Channel: 800.897.8871
E-mail: LGcommercial@lge.com

SPEC_60PG30FC_010908_UP



All screen images are simulated. Dimensions and weights are approximate. Design, features and specifications subject to change without notice.

© Copyright 2009 LG Electronics USA, Inc. All Rights Reserved. "LG Life's Good" is a registered trademark of LG Corp. Dual XD Engine is a trademark of LG Electronics USA, Inc. VESA is a trademark of Video Electronics Standards Association. Dolby and the double-D symbol are registered trademarks of Dolby Laboratories. SRS and the SRS symbol are registered trademarks of SRS Labs, Inc. in the U.S. and selected foreign countries. TruSurround XT is a trademark of SRS Labs, Inc. ENERGY STAR is a registered trademark of the U.S. Environmental Protection Agency. All other corporate and brand names are trademarks of their respective owners.

Printed in the USA. January 2009



LG
Life's Good